

# LED·POL

Spółka z ograniczoną odpowiedzialnością Sp. k.,  
ul Kustronia 40, 43-300 Bielsko-Biała  
tel.: +48 33 822 63 00, e-mail: biuro@led-pol.pl  
www.led-pol.com

PL Instrukcja montażu  
EN Installation guide  
DE Montageanleitung  
CZ Návod k montáži  
SK Montážny návod  
EL Οδηγίες εγκατάστασης  
PT Instruções de instalação  
HU Szerelési útmutató

ORO10033

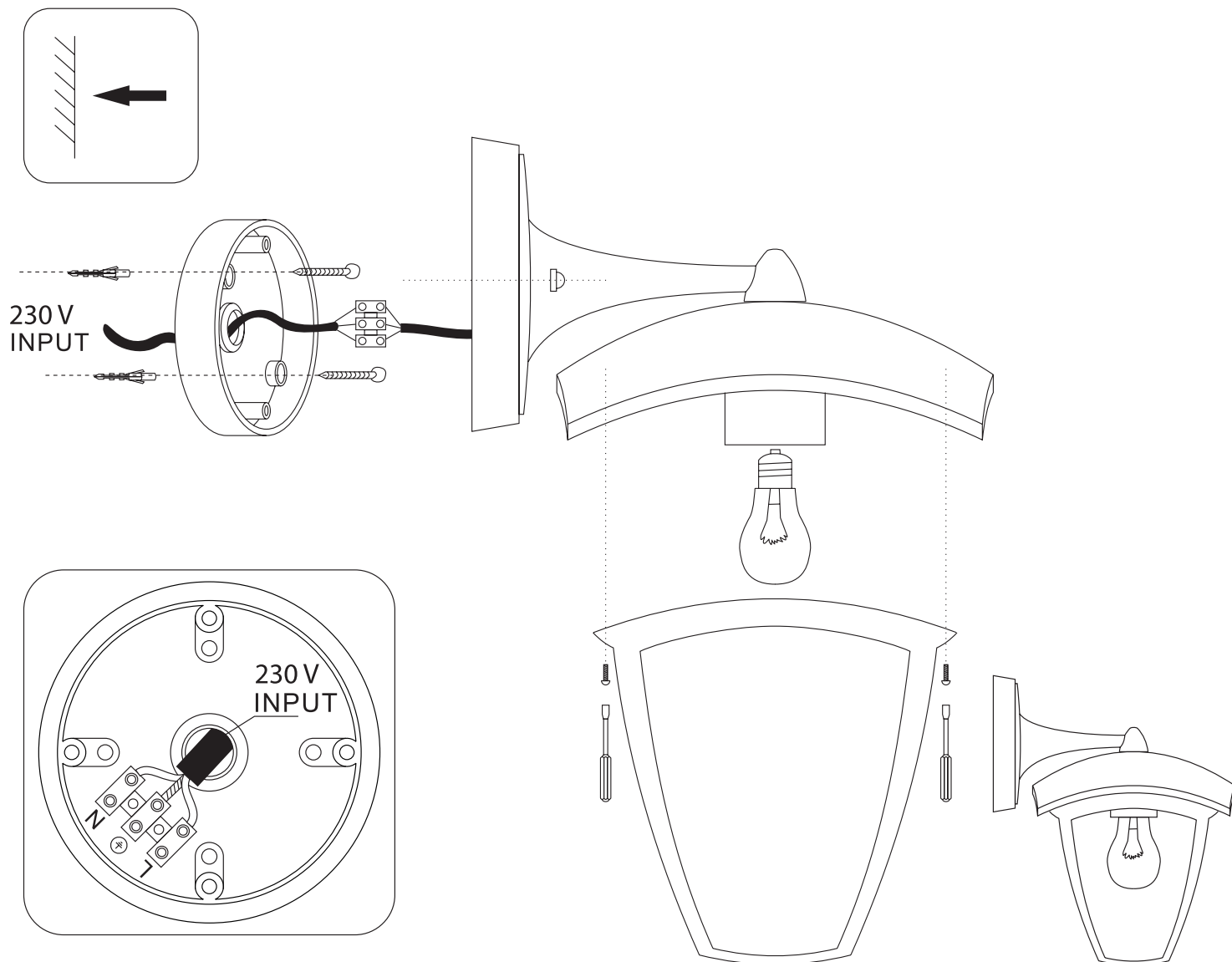

**WAŻNE!** Urządzenie powinno być instalowane przez wykwalifikowanych elektryków.

**IMPORTANT!** Must be installed by qualified electrical contractor.

**WARNUNG!** Die elektrischen Arbeiten, die für die Installation des Gerätes erforderlich sind, müssen von einem qualifizierten Elektriker oder einer sachkundigen Person vorgenommen werden.

**DŮLEŽITÉ UPOZORNĚNÍ!** Zařízení smí instalovat jen řádně kvalifikovaná a oprávněná osoba.

**POZOR!** Zariadenie musí byť inštalované kvalifikovaným elektrikárom.

Η εγκατάσταση και η συντήρηση πρέπει να εκτελούνται από εξειδικευμένο τεχνικό σύμφωνα με τις οδηγίες του κατασκευαστή και τους τοπικούς κανονισμούς ασφαλείας.

**ATENÇÃO!** A instalação deverá ser realizada por técnico especializado.

**VIGYÁZAT!** A készülék szereléséhez, üzembe helyezéséhez szakavatott személy szükséges.



Oprawa jest przystosowana do żarówek o klasach energetycznych:

A++  
A+  
A  
B  
C  
D  
E

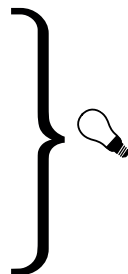

LED-POL

ORO10033

874/2012

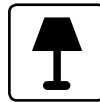

This luminaire is compatible with bulbs of the energy classes:

A++  
A+  
A  
B  
C  
D  
E

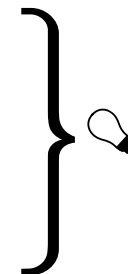

LED-POL

ORO10033

874/2012



Diese Leuchte ist geeignet für Leuchtmittel der Energieklasse:

A++  
A+  
A  
B  
C  
D  
E

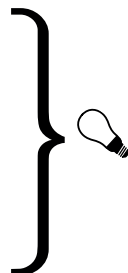

LED-POL

ORO10033

874/2012

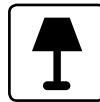

Toto svítidlo je kompatibilní se žárovkami energetických tříd:

A++  
A+  
A  
B  
C  
D  
E

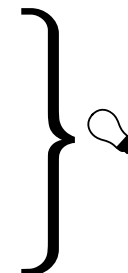

LED-POL

ORO10033

874/2012



Toto svietidlo je kompatibilné so žiarovkami energetických tried:

A++  
A+  
A  
B  
C  
D  
E

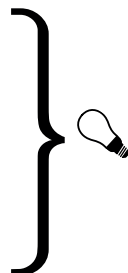

LED-POL

ORO10033

874/2012



Το φωτιστικό αυτό είναι συμβατό με λαμπτήρες ενεργειακής τάξης:

A++  
A+  
A  
B  
C  
D  
E

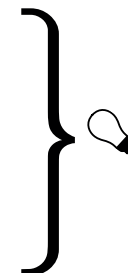

LED-POL

ORO10033

874/2012



Candeeiro compatível com lâmpadas das classes energéticas:

A++  
A+  
A  
B  
C  
D  
E

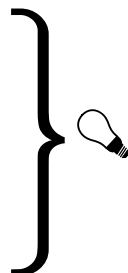

LED-POL

ORO10033

874/2012



A lámpatest a következő energiasztályú égőkkel tud működni:

A++  
A+  
A  
B  
C  
D  
E

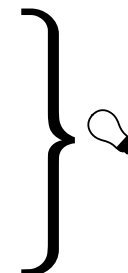

LED-POL

ORO10033

874/2012