

LED·POL

Spółka z ograniczoną odpowiedzialnością Sp. k.,
ul Kustronia 40, 43-300 Bielsko-Biała
tel.: +48 33 822 63 00, e-mail: biuro@led-pol.pl
w w w . l e d - p o l . c o m

PL Instrukcja montażu
EN Installation guide
DE Montageanleitung
CZ Návod k montáži
SK Montážny návod
EL Οδηγίες εγκατάστασης
PT Instruções de instalação
HU Szerelési útmutató

ORO10034

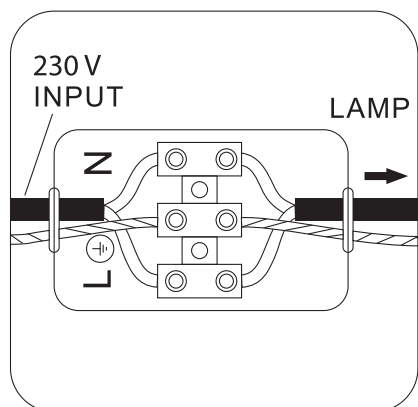
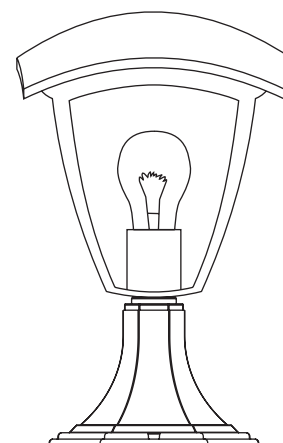
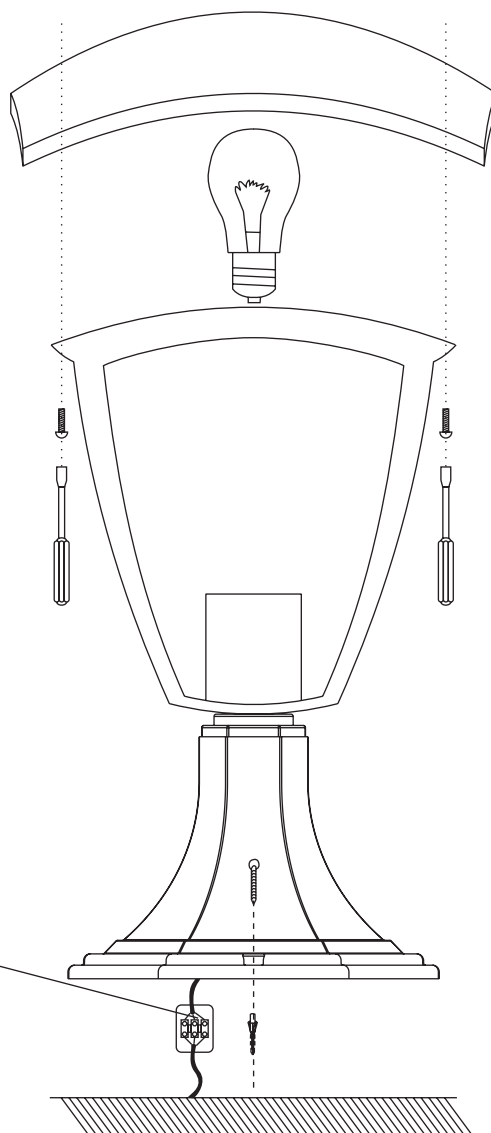
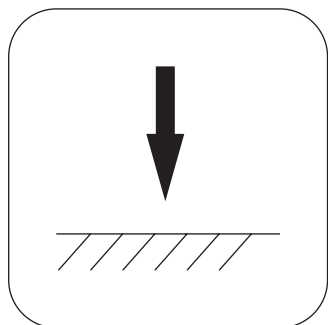

WAŻNE! Urządzenie powinno być instalowane przez wykwalifikowanych elektryków.

IMPORTANT! Must be installed by qualified electrical contractor.

WARNUNG! Die elektrischen Arbeiten, die für die Installation des Gerätes erforderlich sind, müssen von einem qualifizierten Elektriker oder einer sachkundigen Person vorgenommen werden.

DŮLEŽITÉ UPOZORNĚNÍ! Zařízení smí instalovat jen řádně kvalifikovaná a oprávněná osoba.

POZOR! Zariadenie musí byť inštalované kvalifikovaným elektrikárom.

Η εγκατάσταση και η συντήρηση πρέπει να εκτελούνται από εξειδικευμένο τεχνικό σύμφωνα με τις οδηγίες του κατασκευαστή και τους τοπικούς κανονισμούς ασφαλείας.

ATENÇÃO! A instalação deverá ser realizada por técnico especializado.

VIGYÁZAT! A készülék szereléséhez, üzembe helyezéséhez szakavatot személyi szükség.



Oprawa jest przystosowana do żarówek o klasach energetycznych:

A++
A+
A
B
C
D
E

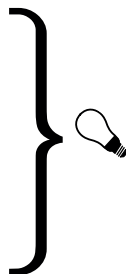

LED-POL

ORO10034

874/2012

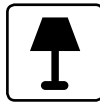

This luminaire is compatible with bulbs of the energy classes:

A++
A+
A
B
C
D
E

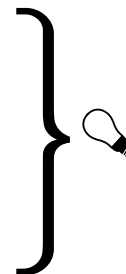

LED-POL

ORO10034

874/2012



Diese Leuchte ist geeignet für Leuchtmittel der Energieklasse:

A++
A+
A
B
C
D
E

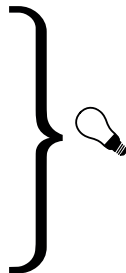

LED-POL

ORO10034

874/2012



Toto svítidlo je kompatibilní se žárovkami energetických tříd:

A++
A+
A
B
C
D
E

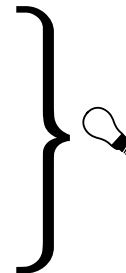

LED-POL

ORO10034

874/2012



Toto svietidlo je kompatibilné so žiarovkami energetických tried:

A++
A+
A
B
C
D
E

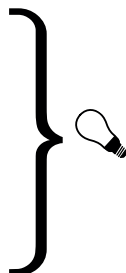

LED-POL

ORO10034

874/2012



Το φωτιστικό αυτό είναι συμβατό με λαμπτήρες ενεργειακής τάξης:

A++
A+
A
B
C
D
E

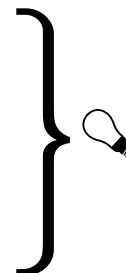

LED-POL

ORO10034

874/2012



Candeeiro compatível com lâmpadas das classes energéticas:

A++
A+
A
B
C
D
E

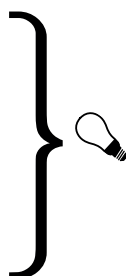

LED-POL

ORO10034

874/2012

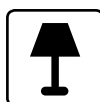

A lámpatest a következő energiasztályú égőkkel tud működni:

A++
A+
A
B
C
D
E

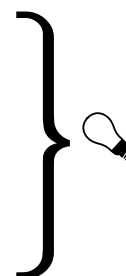

LED-POL

ORO10034

874/2012